

ATS673 and ATS674

Self-Calibrating TPOS Gear Tooth Sensor Optimized for Automotive Cam Sensing Applications

Package SE, 4-pin Through Hole

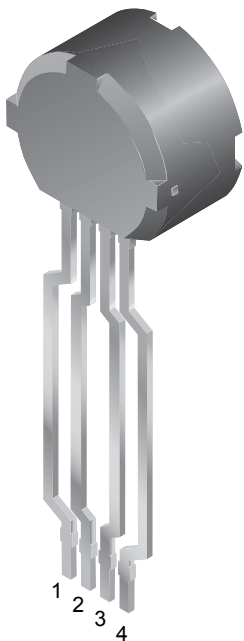

1. VCC
2. VOUT
3. TEST
4. GND

ABSOLUTE MAXIMUM RATINGS

Supply Voltage, V_{CC}	28 V
Reverse-Supply Voltage, V_{RCC}	-18 V
Continuous Output Current, I_{OUT}	20 mA
Reverse-Output Current, I_{ROUT}	50 mA
Operating Temperature	
Ambient, T_A , Range L	-40°C to 150°C
Maximum Junction, $T_{J(max)}$	165°C
Storage Temperature, T_S	-65°C to 170°C

Recognizing the increasingly stringent requirements for EMC/EMI in automotive applications, Allegro has taken the necessary steps to design devices that are capable of withstanding the effects of radiated and conducted transients. The ATS673 and ATS674 devices have been designed specifically for this purpose. Advanced circuitry on the die allows them to survive positive and negative transient pulses on both the input and output.

The ATS673 and ATS674 devices retain all of the same characteristics as the ATS671 and ATS672. The devices remain true zero-speed gear tooth sensors with optimized Hall IC/magnet configuration in an SIP (single in-line package). The SIP assembly consists of a molded package that holds together a samarium cobalt magnet, a pole piece, and a true zero-speed Hall IC that has been optimized to the magnetic circuit.

The sensor incorporates a single element Hall IC that switches in response to magnetic signals created by a ferrous target. The IC contains a sophisticated digital circuit designed to eliminate the detrimental effects of magnet and system offsets. Signal processing is used to provide zero-speed performance independent of air gap and also to dynamically adapt device performance to the typical operating conditions found in automotive applications, particularly cam sensing applications (reduced vibration sensitivity).

High-resolution (9-bit) peak detecting DACs are used to set the adaptive switching thresholds of the devices, ensuring high accuracy even in the presence of gear eccentricity. Hysteresis in the thresholds reduces the negative effects of anomalies in the magnetic signal (such as magnetic overshoot) associated with the targets used in many automotive applications. The ATS673 and 674 also include a low bandwidth filter that increases the noise immunity and the signal to noise ratio of the sensor.

Two options are available for output polarity, low over tooth (LT) and high over tooth (HT). For applications requiring absolute accuracy use the ATS674. The ATS673 should be used for targets with high wobble.

Features and Benefits

- Tight timing accuracy over operating temperature range
- True zero-speed operation
- TPOS (True Power-On State)
- Air-gap-independent switchpoints
- High immunity to vibration
- Large operating air gaps
- Operation with supply voltages down to 3.3 V
- Digital output representing target profile
- Single-chip solution for high reliability
- Optimized Hall IC/magnet system
- AGC and reference adjust circuit
- Undervoltage lockout



ATS673 and ATS674

Self-Calibrating TPOS Gear Tooth Sensor Optimized for Automotive Cam Sensing Applications

Product Selection Guide

Part Number	Pb-free	V _{OUT} (Over Tooth)	Application	Packing*
ATS673LSETN-LT-T	Yes	Low	High target wobble	13-in. reel, 450 pieces/reel
ATS673LSETN-LT	–			
ATS673LSETN-HT-T	Yes	High		
ATS673LSETN-HT	–			
ATS674LSETN-LT-T	Yes	Low	High absolute edge detection accuracy	
ATS674LSETN-LT	–			
ATS674LSETN-HT-T	Yes	High		
ATS674LSETN-HT	–			

*Contact Allegro for additional packing options.

ATS673 and ATS674

Self-Calibrating TPOS Gear Tooth Sensor Optimized for Automotive Cam Sensing Applications

Functional Block Diagram

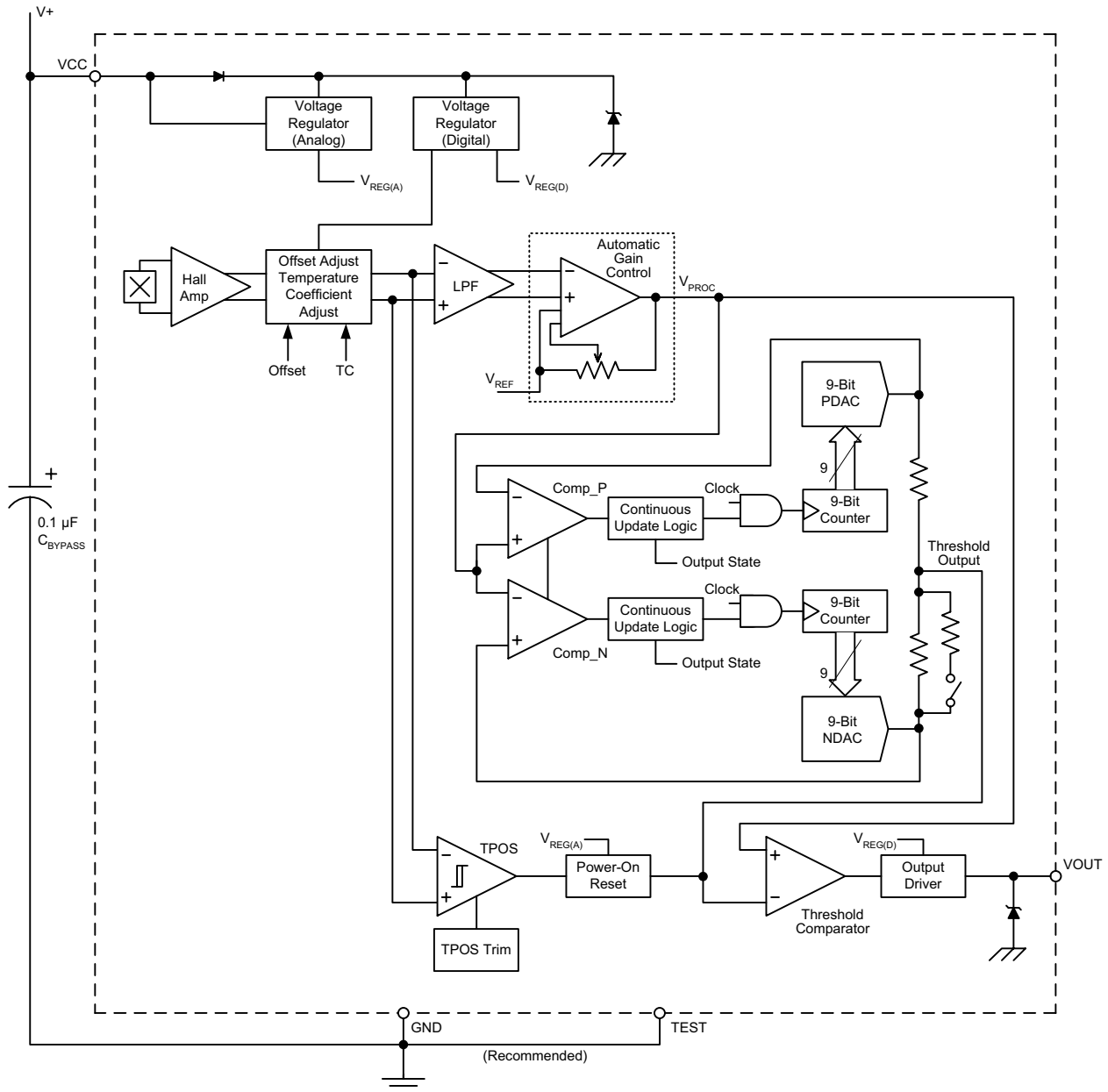

ATS673 and ATS674

Self-Calibrating TPOS Gear Tooth Sensor Optimized for Automotive Cam Sensing Applications

OPERATING CHARACTERISTICS Valid at $T_A = -40^\circ\text{C}$ to 150°C , $T_J \leq T_{J(\text{max})}$, over full range of AG, unless otherwise noted

Characteristic	Symbol	Test Conditions	Min.	Typ. ¹	Max.	Units	
ELECTRICAL CHARACTERISTICS							
Supply Voltage	V_{CC}	Operating; $T_J < T_{J(\text{Max})}$	3.3	–	26.5	V	
Undervoltage Lockout	V_{CCUV}		–	–	$< V_{CC(\text{Min})}$	V	
Supply Zener Clamp Voltage	$V_{Z\text{Supply}}$	$I_{CC} = I_{CC(\text{Max})} + 3 \text{ mA}$, $T_A = 25^\circ\text{C}$	28	31	35	V	
Supply Zener Current ²	$I_{Z\text{Supply}}$	$V_{\text{Supply}} = 27 \text{ V}$	–	–	14	mA	
Supply Current	I_{CC}	Output = OFF or ON	3	6.5	11	mA	
Reverse Supply Current	I_{RCC}	$V_{RCC} = -18 \text{ V}$	–	–5	–10	mA	
POWER-ON CHARACTERISTICS							
Power-On Time ³	t_{PO}	Gear Speed $< 100 \text{ rpm}$; $V_{CC} > V_{CC(\text{Min})}$	–	–	500	μs	
OUTPUT CHARACTERISTICS							
Low Output Voltage	$V_{\text{OUT}(\text{Sat})}$	$I_{\text{SINK}} = 15 \text{ mA}$, Output = ON	–	200	450	mV	
Output Zener Voltage	$V_{Z\text{OUT}}$	$I_{\text{OUT}} = 3 \text{ mA}$, $T_A = 25^\circ\text{C}$	30	–	–	V	
Output Current Limit	I_{OUTLIM}	Output = ON, $V_{\text{OUT}} = 12 \text{ V}$	35	57	90	mA	
Output Leakage Current	I_{OUTOFF}	Output = OFF, $V_{\text{OUT}} = V_{CC(\text{Max})}$	–	–	10	μA	
Output Rise Time	t_r	10/90% points; $R_{\text{LOAD}} = 500 \Omega$, $C_{\text{LOAD}} = 10 \text{ pF}$, $T_A = 25^\circ\text{C}$	–	0.9	5	μs	
Output Fall Time	t_f	10/90% points; $R_{\text{LOAD}} = 500 \Omega$, $C_{\text{LOAD}} = 10 \text{ pF}$, $T_A = 25^\circ\text{C}$	–	0.5	5	μs	
Output Polarity	V_{OUT}	HT device option	Over tooth	–	HIGH	–	V
			Over valley	–	LOW	–	V
		LT device option	Over tooth	–	LOW	–	V
			Over valley	–	HIGH	–	V

Continued on the next page...

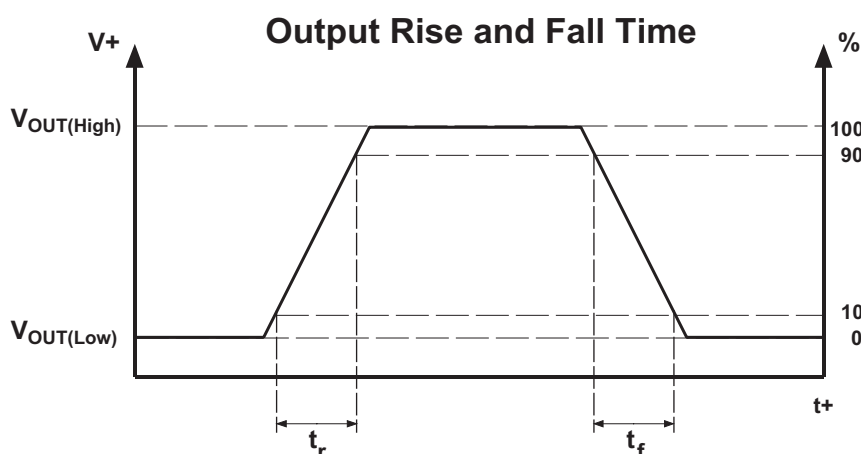

ATS673 and ATS674

Self-Calibrating TPOS Gear Tooth Sensor Optimized for Automotive Cam Sensing Applications

OPERATING CHARACTERISTICS, continued Valid at $T_A = -40^\circ\text{C}$ to 150°C , $T_J \leq T_{J(\text{max})}$, over full range of AG, unless otherwise noted

Characteristic	Symbol	Test Conditions	Min.	Typ. ¹	Max.	Units		
SWITCHPOINT CHARACTERISTICS								
Tooth Speed	S	Tooth frequency, target generating sinusoidal signal	0	–	8	kHz		
Bandwidth	BW	Corresponds to output switching frequency – 3 dB	–	40	–	kHz		
Operate	B_{OP}	ATS673	% of peak-to-peak, referenced to tooth signal,		–	40	%	
		ATS674	AG < $AG_{(\text{Max})}$		–	30	%	
Release	B_{RP}	ATS673	% of peak-to-peak, referenced to tooth signal,		–	50	%	
		ATS674	AG < $AG_{(\text{Max})}$		–	40	%	
CALIBRATION CHARACTERISTICS⁴								
Initial Calibration	Cal_{IC}	Quantity of rising edges required to complete edge detection calibration	–	–	3	edges		
AGC Disable	Cal_{AGC}	Quantity of rising edges required to complete Automatic Gain Control calibration	–	–	3	edges		
Calibration Update	Cal_{UPD}	Quantity of rising edges required to update edge detection calibration while running after initial calibration	–	Continuous	–	edges		
PERFORMANCE CHARACTERISTICS³								
TPOS Air Gap Range ⁵	AG_{TPOS}	TPOS functionality guaranteed	0.5	–	2.5	mm		
Operational Air Gap Range	AG	TPOS guaranteed, output switching, running mode	0.5	–	2.5	mm		
Extended Minimum Air Gap ⁶	AG_{EXTMIN}	Output switching, running mode; valleys may be detected as teeth in this range	–	–	0.5	mm		
Extended Maximum Air Gap ⁷	AG_{EXTMAX}	Output switching, running mode; teeth may be detected as valleys in this range	2.5	–	5	mm		
Relative Timing Accuracy ^{4,8}	Err_{ICREL}	ATS673	During initial calibration; rising or falling edges, gear speed = 1000 rpm, target eccentricity		–	3	deg	
		ATS674	< 0.1 mm		–	3	deg	
	Err_{RELR}	ATS673	Rising edges; after initial calibration, gear speed = 1000 rpm, target eccentricity < 0.1 mm		–	0.5	0.8	deg
		ATS674			–	0.4	0.8	deg
	Err_{RELF}	ATS673	Falling edges; after initial calibration, gear speed = 1000 rpm, target eccentricity < 0.1 mm		–	0.8	1.2	deg
		ATS674			–	0.6	1.2	deg
Phase Delay ⁹	ΔErr_{SREL}	After initial calibration, AG = 1.5 mm, $T_A = 25^\circ\text{C}$	–	1.6×10^{-4}	–	deg/rpm		

¹Typical values are taken at $V_{CC} = 12\text{ V}$ and $T_A = 25^\circ\text{C}$.

² $I_{ZSupply(\text{Max})}$ is equivalent to $I_{CCON(\text{Max})} + 3\text{ mA}$.

³Using reference target 8X.

⁴The term *edge* refers to a mechanical edge, such as the side of a gear tooth, passing under the device. Rising edge: from valley to approaching tooth. Falling edge: from tooth to approaching valley.

⁵The TPOS Air Gap Range is the range of installation air gaps within which the TPOS (True Power-On State) function is guaranteed to correctly detect a tooth when powered-on over a tooth and correctly detecting a valley when powered-on over a valley, using reference target 8X or equivalent, as specified in the Target/Gear Parameters for Correct TPOS Operation section in this document.

⁶The Extended Minimum Air Gap is a range of installation air gaps, smaller than $AG_{(\text{Min})}$, within which the the device will accurately detect target features but TPOS is NOT guaranteed to be fully accurate, possibly evaluating the initial valley as a tooth.

⁷The Extended Maximum Air Gap is an extended range of installation air gaps, greater than $AG_{(\text{Max})}$, within which the the device will accurately detect target features but TPOS is not guaranteed to be fully accurate, possibly evaluating the initial tooth as a valley.

⁸Relative Timing Accuracy is the change in edge position before the resulting change in device output; for a single device, over the full Operational Air Gap Range, AG, and Operating Ambient Temperature, T_A , range.

⁹Phase Delay is the change in edge position at detection, through the full operational Tooth Speed, S, range for a single device, and at a single ambient temperature, T_A , and installation air gap, AG.

ATS673 and ATS674

Self-Calibrating TPOS Gear Tooth Sensor Optimized for Automotive Cam Sensing Applications

Air Gap Comparisons

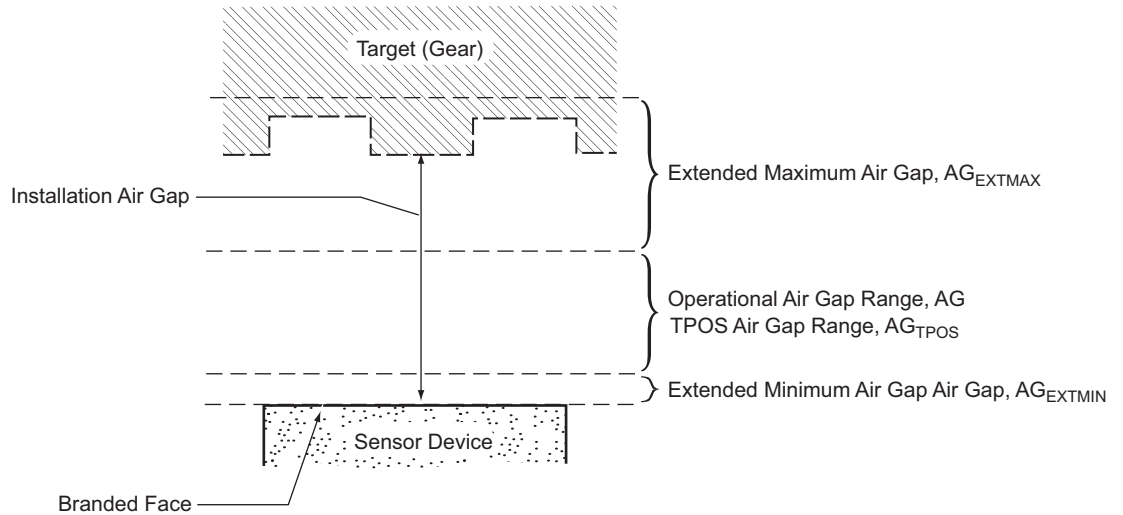

Relative Timing Accuracy

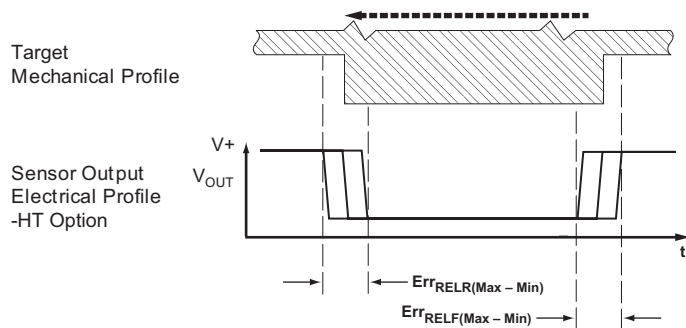

ATS673 and ATS674

Self-Calibrating TPOS Gear Tooth Sensor Optimized for Automotive Cam Sensing Applications

Reference Target (Gear) Information

REFERENCE TARGET 8X

Characteristic	Symbol	Test Conditions	Typ.	Units	Symbol Key
Outside Diameter	D_o	Outside diameter of target	120	mm	
Face Width	F	Breadth of tooth, with respect to sensor	6	mm	
Circular Tooth Length	t	Length of tooth, with respect to sensor; measured at D_o	23.6	mm	
Circular Valley Length	t_v	Length of valley, with respect to sensor; measured at D_o	23.6	mm	
Tooth Whole Depth	h_t		5	mm	
Material		CRS 1018	-	-	

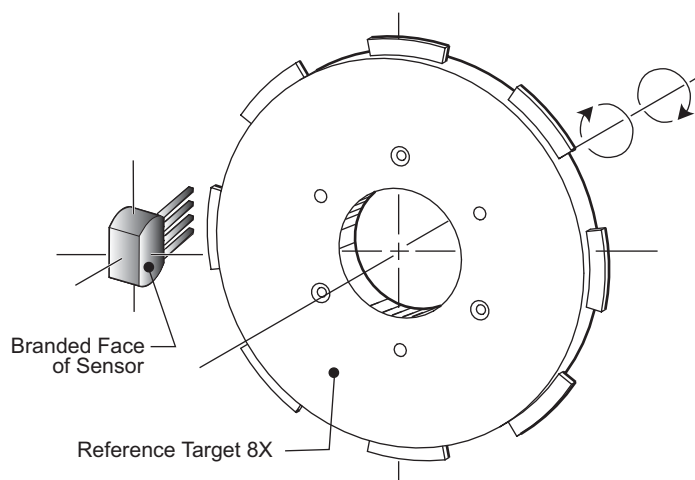

Figure 1. Configuration with Reference Target

Target/Gear Parameters for Correct TPOS Operation

For TPOS to function as specified, the target must generate a minimum of 120 G difference between the magnetic field over a tooth and the field over a valley, at the maximum installation air gap. A target complying with the material and dimensions cited for the reference target 8X, generates the required 120 G differential.

The following recommendations should be followed in the design and specification of targets:

- Tooth width, $t \geq 5$ mm
- Valley width, $t_v > 13$ mm
- Valley depth, $h_t > 5$ mm
- Tooth thickness, $F \geq 5$ mm

ATS673 and ATS674

Self-Calibrating TPOS Gear Tooth Sensor Optimized for Automotive Cam Sensing Applications

Characteristic Data: Electrical

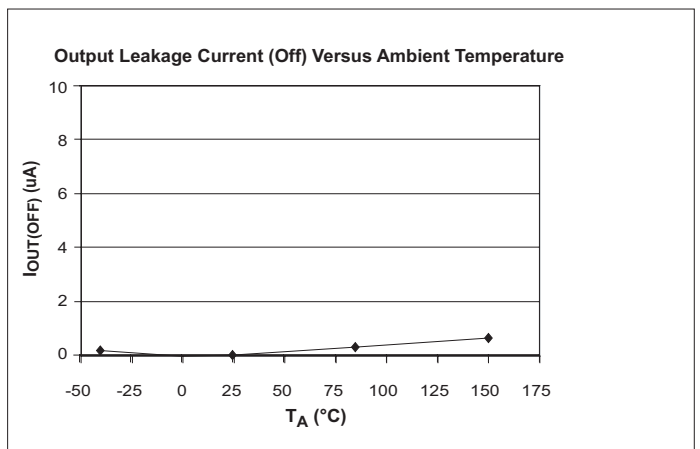
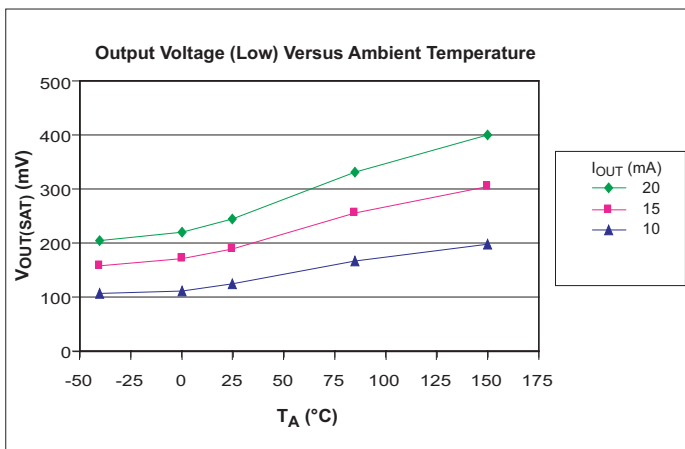
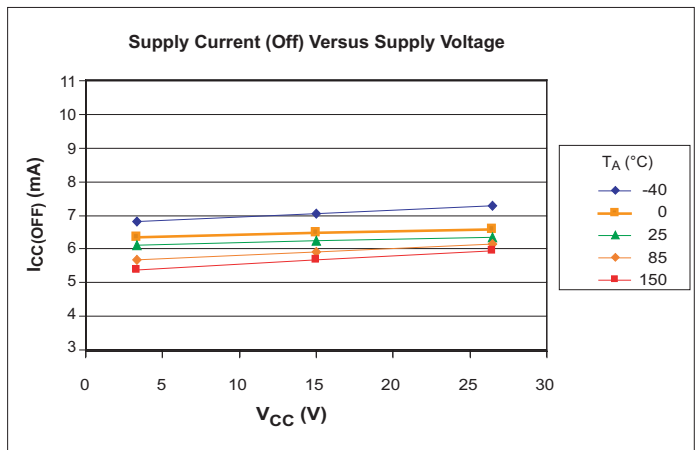
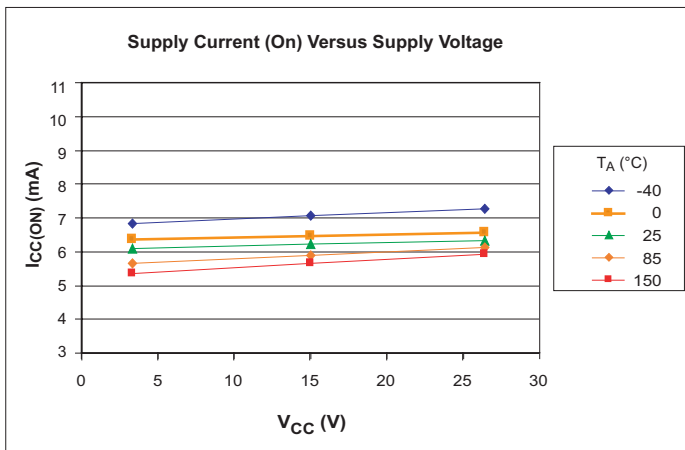
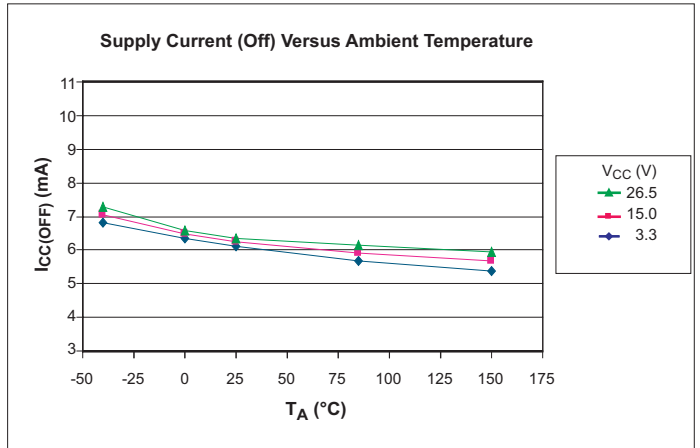
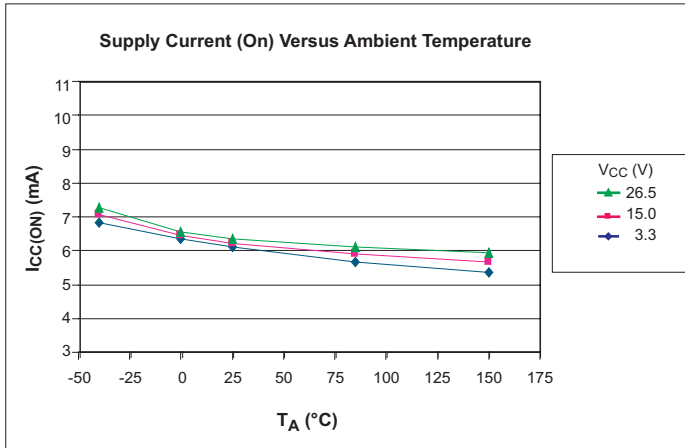

ATS673 and ATS674

Self-Calibrating TPOS Gear Tooth Sensor Optimized for Automotive Cam Sensing Applications

Characteristic Data: Relative Timing Accuracy

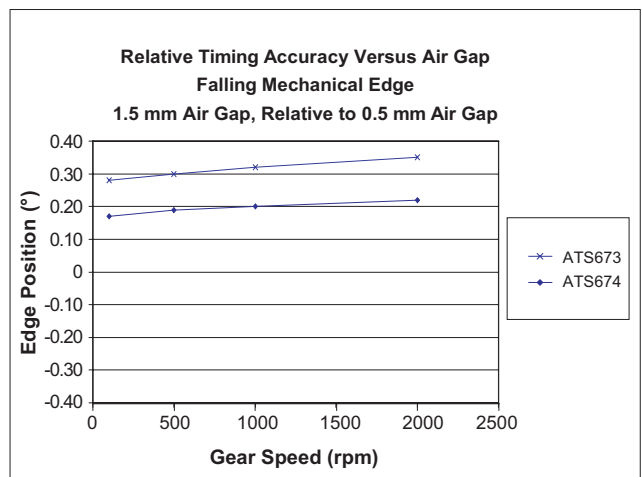
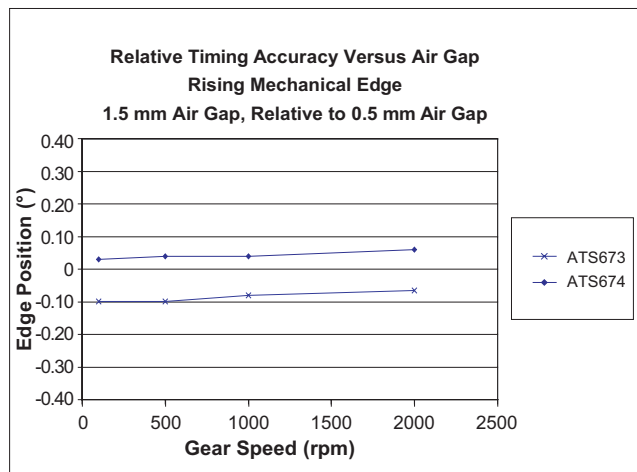
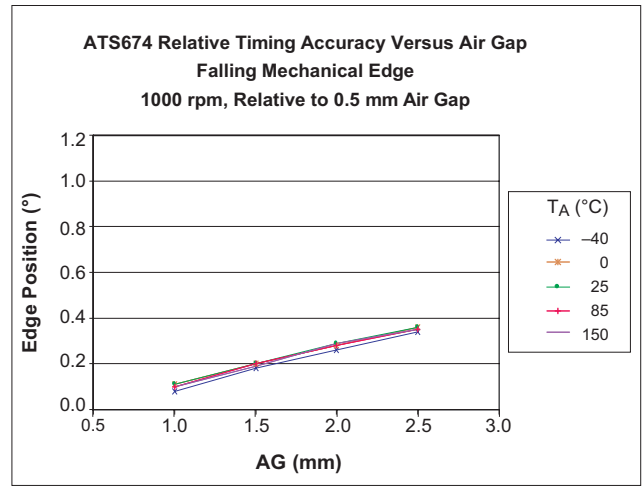
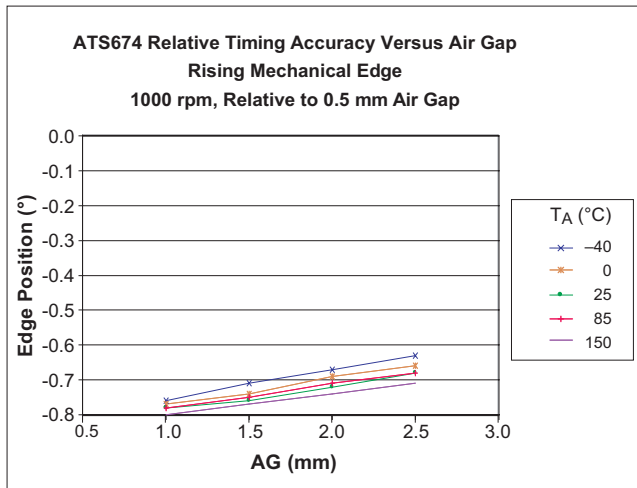
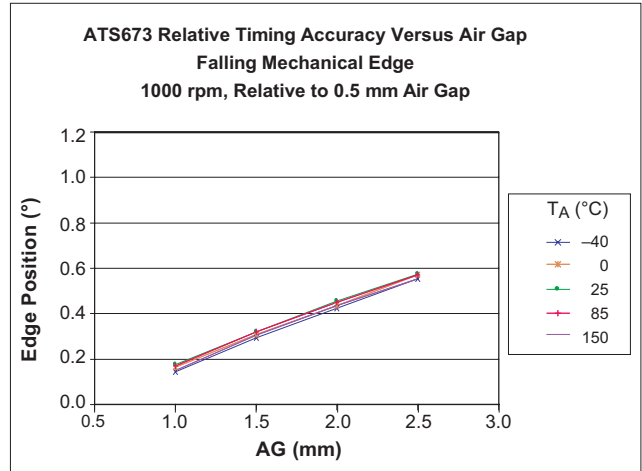
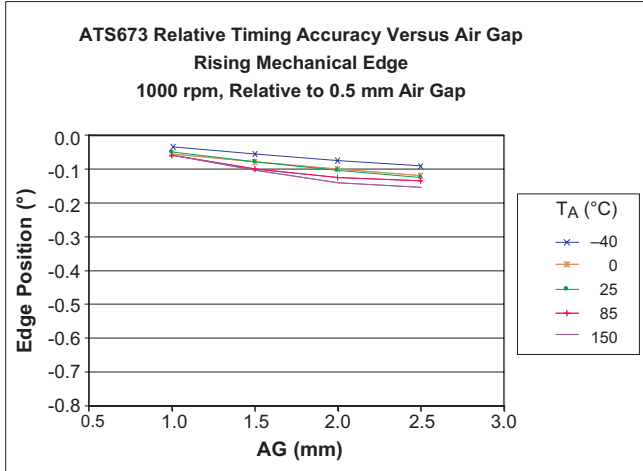

ATS673 and ATS674

Self-Calibrating TPOS Gear Tooth Sensor Optimized for Automotive Cam Sensing Applications

Operational Description

Assembly Description

The ATS673 and ATS674 true zero-speed gear tooth sensors have a Hall IC-magnet configuration that is fully optimized to provide digital detection of gear tooth edges. This sensor is integrally molded into a plastic body that has been optimized for size, ease of assembly, and manufacturability. High operating temperature materials are used in all aspects of construction.

Sensing Technology

The gear tooth sensor contains a single-chip Hall effect sensor IC, a 4-pin leadframe and a specially designed rare-earth magnet. The Hall IC supports a Hall element that measures the magnetic gradient created by the passing of a ferrous object. This

is illustrated in figure 2. The difference in the magnetic gradients created by teeth and valleys allows the devices to generate a digital output signal.

Output

After proper power is applied to the devices, they are then capable of providing digital information that is representative of the profile of a rotating gear, as illustrated in figure 3. No additional optimization is needed and minimal processing circuitry is required. This ease of use reduces design time and incremental assembly costs for most applications.

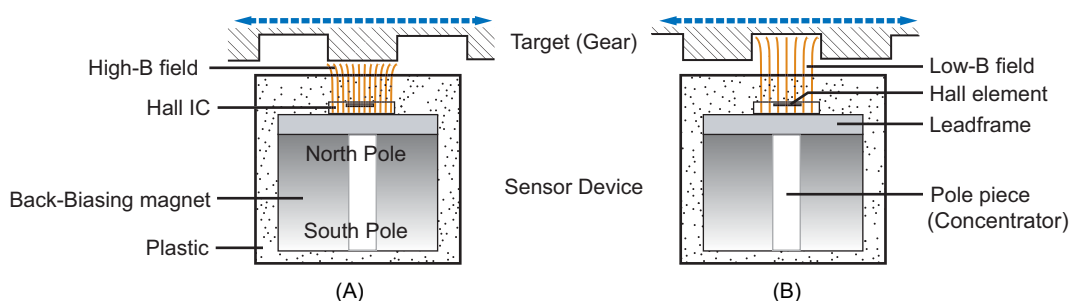

Figure 2. Device Cross Section. Motion of the target is detected by the Hall element mounted on the Hall IC. Panel A, the presence of a tooth feature on the target is distinguished by a high magnetic flux density, B. Panel B, the presence of a valley feature is distinguished by its low magnetic flux density.

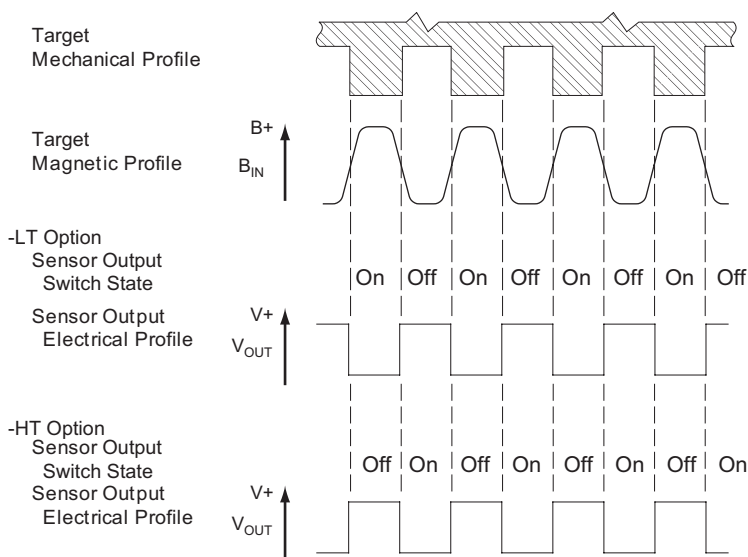

Figure 3. The magnetic profile reflects the geometry of the target, allowing the device to present an accurate digital output response.

ATS673 and ATS674

Self-Calibrating TPOS Gear Tooth Sensor Optimized for Automotive Cam Sensing Applications

TPOS (True Power-On State) Operation

Under specified operating conditions, the devices are guaranteed to attain a specified output voltage polarity at power-on, in relation to the target feature nearest the device at that time. Both devices offer the options of either high or low polarity over initial tooth or valley. This polarity also applies throughout device operation.

Start-Up Detection

These devices provide an output polarity transition at the first mechanical edge after power-on.

Undervoltage Lockout

When the supply voltage falls below the undervoltage lockout level, V_{CCUV} , the device switches to the OFF state. The device remains in that state until the voltage level is restored to the V_{CC} operating range. Changes in the target magnetic profile have no effect until voltage is restored. This prevents false signals caused by undervoltage conditions from propagating to the output of the sensor.

Power Supply Protection

The ATS673 and ATS674 contain an on-chip regulator and can operate over a wide range of supply voltage levels. For applications using an unregulated power supply, transient protection must be added externally. For applications using a regulated supply line, EMI and RFI protection may still be required. The circuit shown in figure 5 is the basic configuration required for proper device operation. Contact Allegro field applications engineering for information on the circuitry required for compliance to various EMC specifications.

Internal Electronics

These devices contain a self-calibrating Hall effect IC that provides a Hall element, a temperature compensated amplifier, and offset cancellation circuitry. The IC also contains a voltage regulator that provides supply noise rejection over the operating voltage range. The Hall transducers and the electronics are integrated on the same silicon substrate by a proprietary BiCMOS process. Changes in temperature do not greatly affect this device due to the stable amplifier design and the offset rejection circuitry.

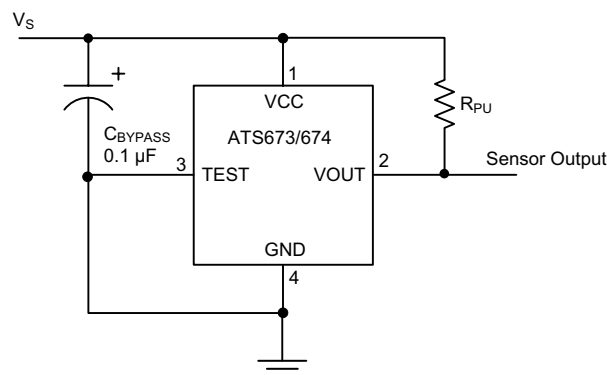

Figure 5. Power Supply Protection Typical Circuit

ATS673 and ATS674

Self-Calibrating TPOS Gear Tooth Sensor Optimized for Automotive Cam Sensing Applications

AGC (Automatic Gain Control)

The AGC feature is implemented by a unique patented self-calibrating circuitry. After each power-on, the devices measure the peak-to-peak magnetic signal. The gain of the sensor is then

adjusted, keeping the internal signal amplitude constant over the air gap range of the device. This feature ensures that operational characteristics are isolated from the effects of changes in AG. The effect of AGC is shown in figure 7.

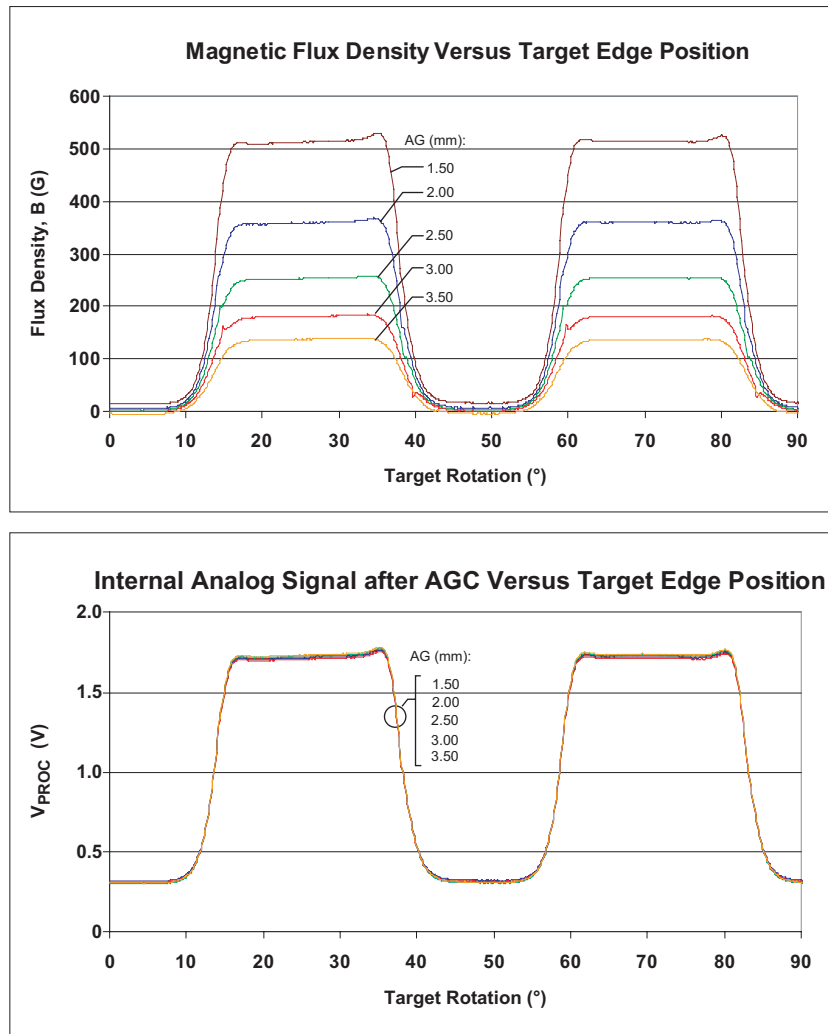

Figure 7. Effect of AGC. The upper panel shows the magnetic gradient detected at the Hall element, with no amplification. The lower panel displays the corresponding internal processed signal, V_{PROC} . This normalized electrical signal allows optimal performance by the rest of the circuits that reference this signal.

ATS673 and ATS674

Self-Calibrating TPOS Gear Tooth Sensor Optimized for Automotive Cam Sensing Applications

Switchpoints

Switchpoints in the ATS673 and ATS674 are established dynamically as a percentage of the amplitude of the signal, V_{PROC} , after normalization with AGC. Two DACs track the peaks of V_{PROC} (see the *Update* subsection).

The switching thresholds are established at fixed percentages of the values held in the two DACs. The value of the thresholds has been carefully selected, where the signal is steepest and least affected by air gap variation, thus providing the most accurate and consistent switching.

The low hysteresis, 10%, provides high performance over various air gaps while maintaining immunity to false switching on noise, vibration, backlash, or other transient events.

Figure 8 graphically demonstrates the establishment of the switching threshold levels. Because the thresholds are established dynamically as a percentage of the peak-to-peak signal, the effect of a baseline shift is minimized.

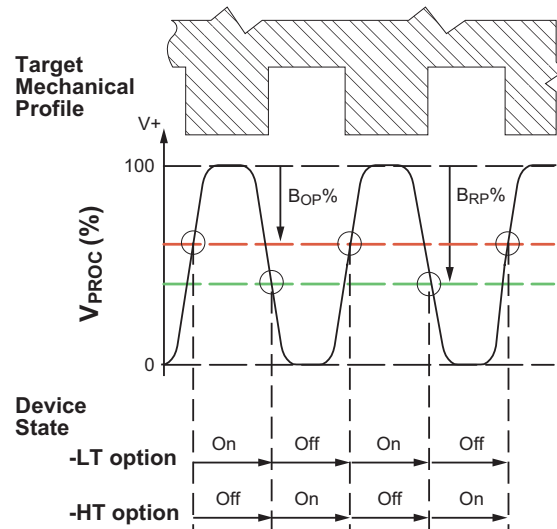

Figure 8. Switchpoint Relationship to Thresholds. The device switches when V_{PROC} passes a threshold level, B_{OP} or B_{RP} , while changing in the corresponding direction: increasing for a B_{OP} switchpoint, and decreasing for a B_{RP} switchpoint.

ATS673 and ATS674

Self-Calibrating TPOS Gear Tooth Sensor Optimized for Automotive Cam Sensing Applications

Update

The ATS673 and ATS674 incorporate an algorithm that continuously monitors the system and updates the switching thresholds accordingly. The switchpoint for each transition is determined by the previous two transitions. Because variations are tracked

in real time, the sensor has high immunity to target run-out and retains excellent accuracy and functionality in the presence of both run-out and transient mechanical events. Figure 9 shows how the devices use historical data to provide the switching thresholds for a given edge.

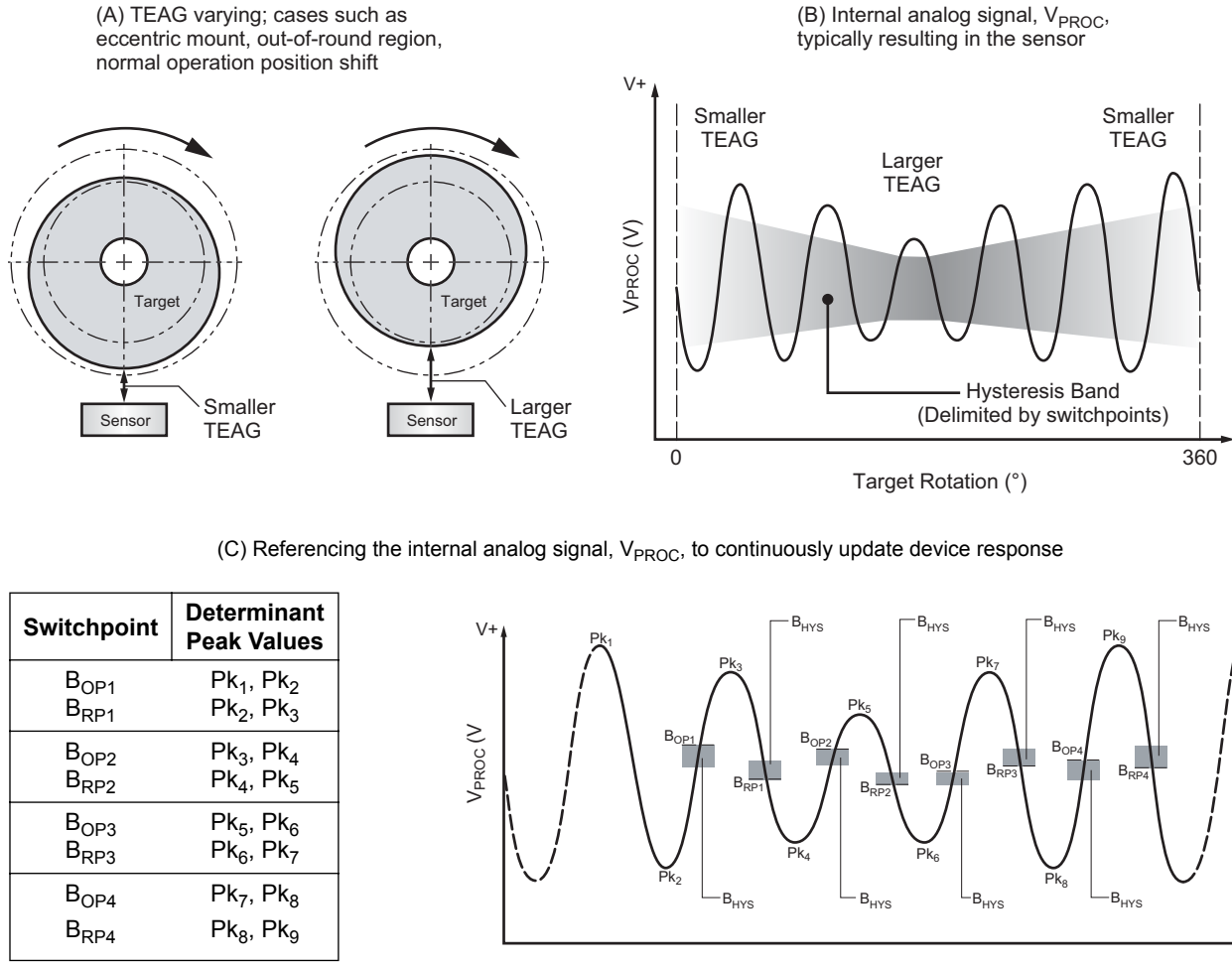

Figure 9. The Continuous Update algorithm allows the Allegro sensor to immediately interpret and adapt to significant variances in the magnetic field generated by the target as a result of eccentric mounting of the target, out-of-round target shape, elevation due to lubricant build-up in journal gears, and similar dynamic application problems that affect the TEAG (Total Effective Air Gap). The algorithm is used to dynamically establish and subsequently update the device switchpoints (B_{OP} and B_{RP}). The hysteresis, $B_{HYS(\#x)}$, at each target feature configuration results from this recalibration, ensuring that it remains properly proportioned and centered within the peak-to-peak range of the internal analog signal, V_{PROC} .

As shown in panel A, the variance in the target position results in a change in the TEAG. This affects the sensor as a varying magnetic field, which results in proportional changes in the internal analog signal, V_{PROC} , shown in panel B. The Continuous Update algorithm is used to establish accurate switchpoints based on the fluctuation of V_{PROC} , as shown in panel C.

Sensor and Target Evaluation

Magnetic Profile

In order to establish the proper operating specification for a particular sensor device and target system, a systematic evaluation of the magnetic circuit should be performed. The first step is the generation of a magnetic map of the target. By using a calibrated device, a magnetic profile of the system is made. Figure 10 is a magnetic map of the 8X reference target.

A pair of curves can be derived from this map data, and be used to describe the tooth and valley magnetic field strength, B , versus the size of the air gap, AG . This allows determination of the minimum amount of magnetic flux density that guarantees operation of the sensor, so the system designer can determine the maximum allowable AG for the sensor and target system. One can also determine the TPOS air gap capabilities of the sensor by comparing the minimum tooth signal to the maximum valley signal.

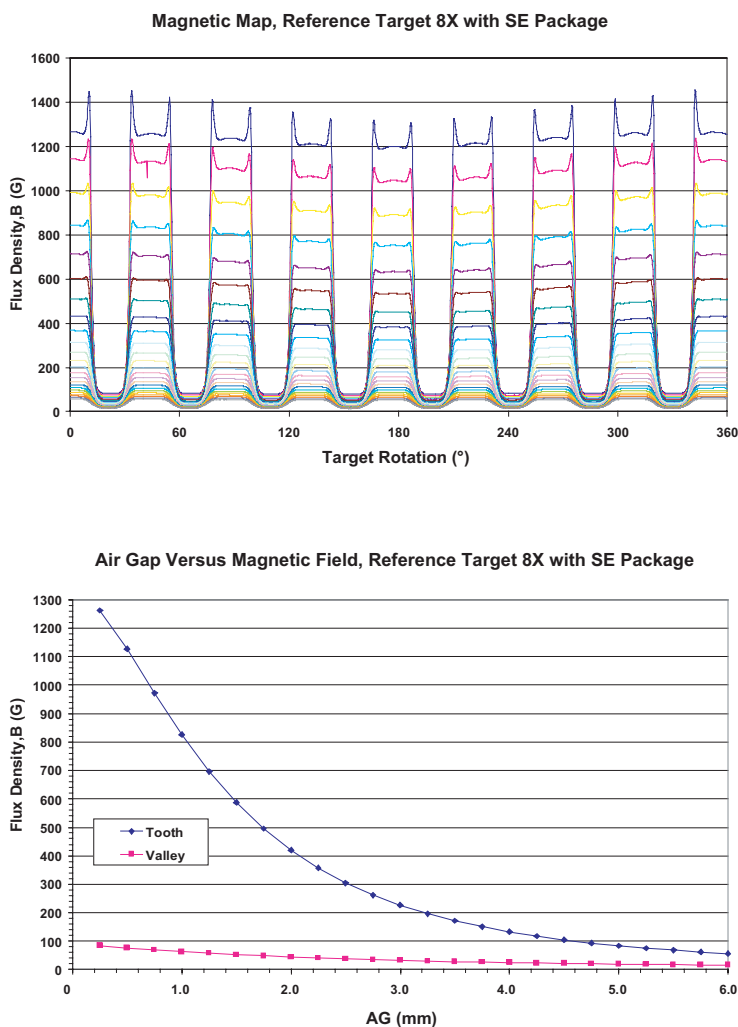

Figure 10. Magnetic Data for the 8X Reference Target and SE package.

ATS673 and ATS674

Self-Calibrating TPOS Gear Tooth Sensor Optimized for Automotive Cam Sensing Applications

Accuracy

While the update algorithm will allow the sensor devices to adapt to typical air gap variations, major changes in air gap can adversely affect switching performance. When characterizing sensor performance over a significant air gap range, be sure to

repower the device at each test at different air gaps. This ensures that self-calibration occurs for each installation condition. See the *Operating Characteristics* table and the charts in the *Characteristic Data: Relative Timing Accuracy* section for performance information.

Sensor Evaluation: EMC

Characterization Only

Test Name*	Reference Specification
ESD – Human Body Model	AEC-Q100-002
ESD – Machine Model	AEC-Q100-003
Conducted Transients	ISO 7637-1
Direct RF Injection	ISO 11452-7
Bulk Current Injection	ISO 11452-4
TEM Cell	ISO 11452-3

*Please contact Allegro for EMC performance

Mechanical Information

Component	Material	Description	Value
Back-biasing Magnet	Rare Earth	South pole behind IC	
Sensor Package Material	Thermoset Epoxy	Maximum Temperature	170°C ^a
Leads	Copper		Solder, Tin/Lead 90/10 ^b

^aTemperature excursions of up to 260°C for 2 minutes or less are permitted (based on delamination studies).

^bIndustry accepted soldering techniques are acceptable for this package as long as the indicated maximum temperature is not exceeded.

Related Documents

Documents that can be found on the Allegros web site, :
www.allegromicro.com:

- Definition of Terms (Pub 26004)
- Hall-Effect Devices: Soldering, Gluing, Potting, Encapsulating, and Lead forming (AN27703.1)
- Storage of Semiconductor Devices (Pub 26011)
- Hall Effect Applications Guide (Pub 27701)
- Applications Note: Back-Biased Packaging Advances (SE, SG & SH versus SA & SB)

ATS673 and ATS674

Self-Calibrating TPOS Gear Tooth Sensor Optimized for Automotive Cam Sensing Applications

Power Derating

THERMAL CHARACTERISTICS may require derating at maximum conditions, see application information

Characteristic	Symbol	Test Conditions*	Value	Units
Package Thermal Resistance	$R_{\theta JA}$	Minimum-K PCB (single layer, single-sided, with copper limited to solder pads)	101	$^{\circ}\text{C}/\text{W}$
		Low-K PCB (single-layer, single-sided with copper limited to solder pads and 3.57 in. ² (23.03 cm ²) of copper area each side)	77	$^{\circ}\text{C}/\text{W}$

*Additional information is available on the Allegro Web site.

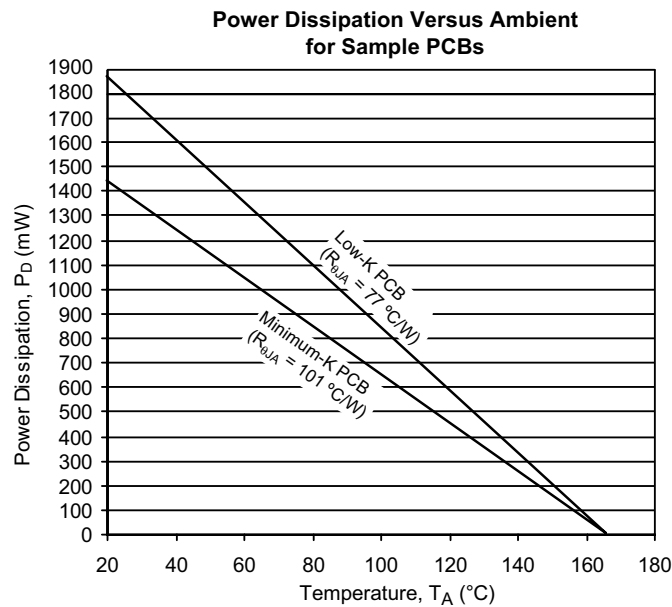
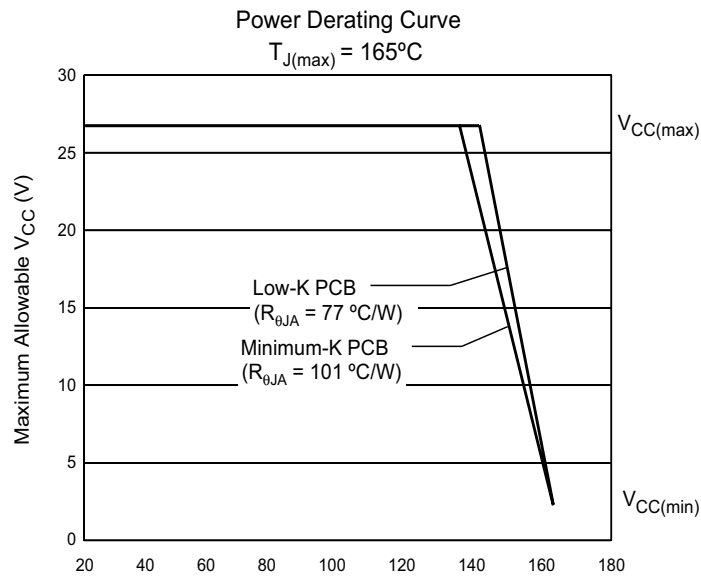

ATS673 and ATS674

Self-Calibrating TPOS Gear Tooth Sensor Optimized for Automotive Cam Sensing Applications

The device must be operated below the maximum junction temperature of the device, $T_{J(\max)}$. Under certain combinations of peak conditions, reliable operation may require derating supplied power or improving the heat dissipation properties of the application. This section presents a procedure for correlating factors affecting operating T_J . (Thermal data is also available on the Allegro MicroSystems Web site.)

The Package Thermal Resistance, $R_{\theta JA}$, is a figure of merit summarizing the ability of the application and the device to dissipate heat from the junction (die), through all paths to the ambient air. Its primary component is the Effective Thermal Conductivity, K , of the printed circuit board, including adjacent devices and traces. Radiation from the die through the device case, $R_{\theta JC}$, is relatively small component of $R_{\theta JA}$. Ambient air temperature, T_A , and air motion are significant external factors, damped by overmolding.

The effect of varying power levels (Power Dissipation, P_D), can be estimated. The following formulas represent the fundamental relationships used to estimate T_J , at P_D .

$$P_D = V_{IN} \times I_{IN} \quad (1)$$

$$\Delta T = P_D \times R_{\theta JA} \quad (2)$$

$$T_J = T_A + \Delta T \quad (3)$$

For example, given common conditions such as: $T_A = 25^\circ\text{C}$, $V_{IN} = 12\text{ V}$, $I_{IN} = 4\text{ mA}$, and $R_{\theta JA} = 140\text{ }^\circ\text{C/W}$, then:

$$P_D = V_{IN} \times I_{IN} = 12\text{ V} \times 4\text{ mA} = 48\text{ mW}$$

$$\Delta T = P_D \times R_{\theta JA} = 48\text{ mW} \times 140\text{ }^\circ\text{C/W} = 7^\circ\text{C}$$

$$T_J = T_A + \Delta T = 25^\circ\text{C} + 7^\circ\text{C} = 32^\circ\text{C}$$

A worst-case estimate, $P_{D(\max)}$, represents the maximum allowable power level, without exceeding $T_{J(\max)}$, at a selected $R_{\theta JA}$ and T_A .

Example: Reliability for V_{CC} at $T_A = 150^\circ\text{C}$, package SE, using minimum-K PCB.

Observe the worst-case ratings for the device, specifically: $R_{\theta JA} = 101\text{ }^\circ\text{C/W}$, $T_{J(\max)} = 165^\circ\text{C}$, $V_{CC(\max)} = 26.5\text{ V}$, and $I_{CC(\max)} = 11\text{ mA}$. Note that $I_{CC(\max)}$ at $T_A = 150^\circ\text{C}$ is lower than the $I_{CC(\max)}$ at $T_A = 25^\circ\text{C}$ given in the Operating Characteristics table.

Calculate the maximum allowable power level, $P_{D(\max)}$. First, invert equation 3:

$$\Delta T_{\max} = T_{J(\max)} - T_A = 165^\circ\text{C} - 150^\circ\text{C} = 15^\circ\text{C}$$

This provides the allowable increase to T_J resulting from internal power dissipation. Then, invert equation 2:

$$P_{D(\max)} = \Delta T_{\max} \div R_{\theta JA} = 15^\circ\text{C} \div 101\text{ }^\circ\text{C/W} = 91\text{ mW}$$

Finally, invert equation 1 with respect to voltage:

$$V_{CC(\text{est})} = P_{D(\max)} \div I_{CC(\max)} = 91\text{ mW} \div 11\text{ mA} = 8.3\text{ V}$$

The result indicates that, at T_A , the application and device can dissipate adequate amounts of heat at voltages $\leq V_{CC(\text{est})}$.

Compare $V_{CC(\text{est})}$ to $V_{CC(\max)}$. If $V_{CC(\text{est})} \leq V_{CC(\max)}$, then reliable operation between $V_{CC(\text{est})}$ and $V_{CC(\max)}$ requires enhanced $R_{\theta JA}$. If $V_{CC(\text{est})} \geq V_{CC(\max)}$, then operation between $V_{CC(\text{est})}$ and $V_{CC(\max)}$ is reliable under these conditions.

ATS673 and ATS674

Self-Calibrating TPOS Gear Tooth Sensor Optimized for Automotive Cam Sensing Applications

Package SE, 4-Pin SIP

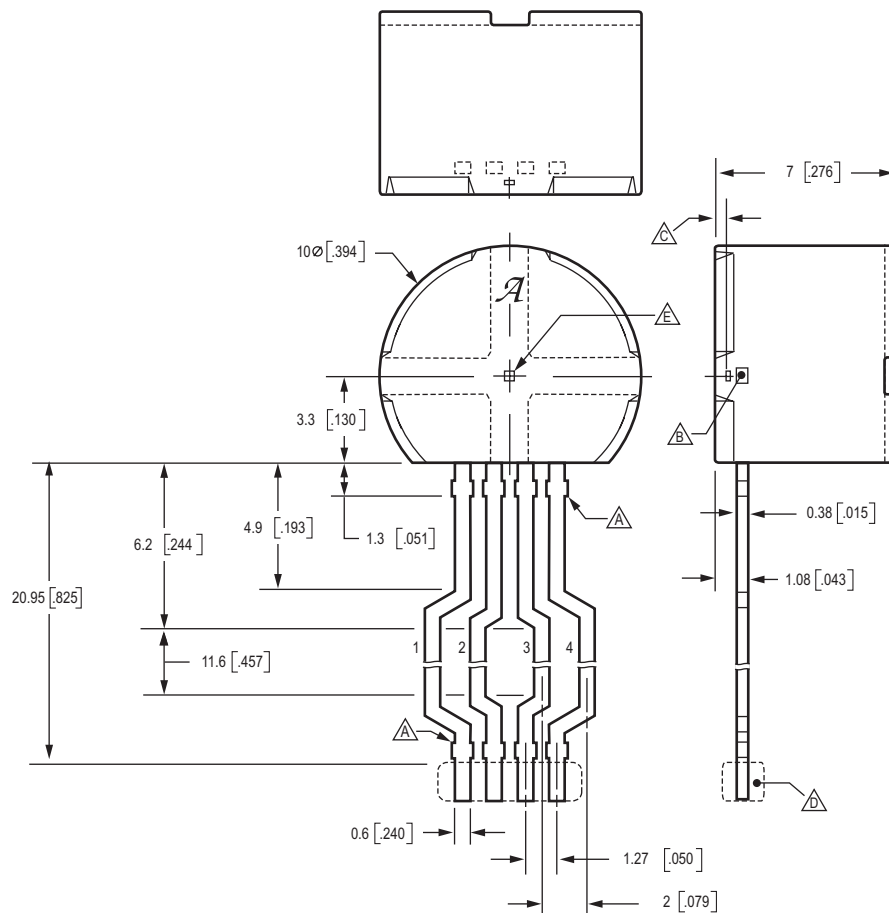

- Dimensions in millimeters. Untoleranced dimensions are nominal.
 U.S. Customary dimensions (in.) in brackets, for reference only
- Dambar removal protrusion
 - Metallic protrusion, electrically connected to pin 4 and substrate (both sides)
 - Active Area Depth 0.43 mm [0.017]
 - Thermoplastic Molded Lead Bar for alignment during shipment
 - Hall element (size not to scale)

ATS673 and ATS674

Self-Calibrating TPOS Gear Tooth Sensor Optimized for Automotive Cam Sensing Applications

The products described herein are manufactured under one or more of the following U.S. patents: 5,045,920; 5,264,783; 5,442,283; 5,389,889; 5,581,179; 5,517,112; 5,619,137; 5,621,319; 5,650,719; 5,686,894; 5,694,038; 5,729,130; 5,917,320; 6,297,627; 6,525,531; and other patents pending.

Allegro MicroSystems, Inc. reserves the right to make, from time to time, such departures from the detail specifications as may be required to permit improvements in the performance, reliability, or manufacturability of its products. Before placing an order, the user is cautioned to verify that the information being relied upon is current.

Allegro products are not authorized for use as critical components in life-support devices or systems without express written approval.

The information included herein is believed to be accurate and reliable. However, Allegro MicroSystems, Inc. assumes no responsibility for its use; nor for any infringement of patents or other rights of third parties which may result from its use.

Copyright © 2005, Allegro MicroSystems, Inc.